

**Data sheet**

# Thermostats Type RT

**Description**



A thermostat is a temperature-controlled switch. The position of the contacts depends on the temperature of the sensor and the set scale value. The RT series covers thermostats for general industrial and marine applications, including differential thermostats with room sensors, duct sensors, and capillary tube sensors

**Contents**

	Page
Description .....	1
Survey of types, temperature ranges .....	2
Technical data and code nos. all types .....	3
Nomograms .....	5
Technical data .....	7
Approvals .....	7
Dimensions and weight .....	8
Choice of suitable sensor pocket .....	8
Installation, setting .....	9
Function .....	10
Types of charge .....	11
Thermostat for control of ventilation plant .....	12
Thermostats with adjustable neutral zone .....	13
Differential thermostats .....	14
Spare parts and accessories .....	15

**Thermostats type RT**

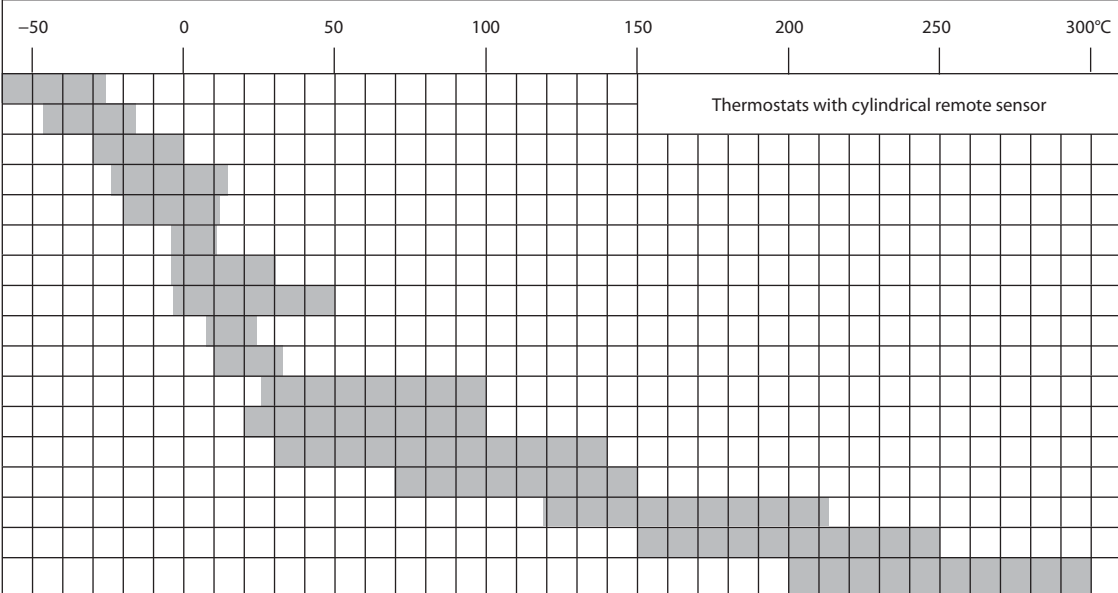
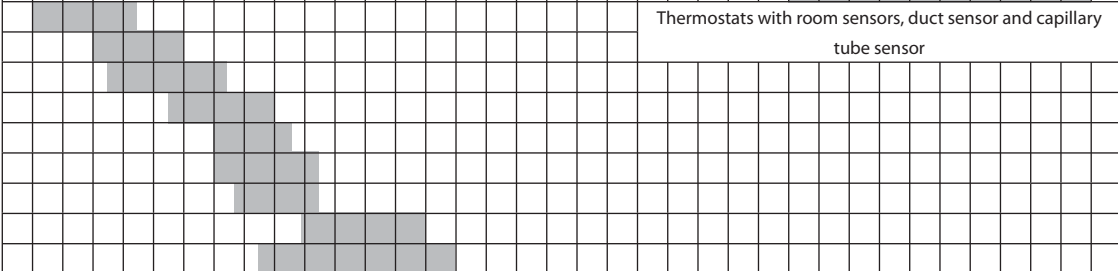
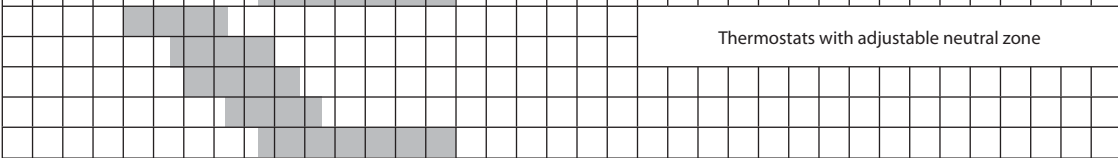
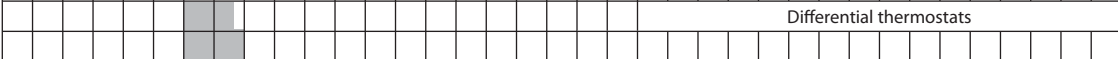
-50	0	50	100	150	200	250	300°C	Range p <sub>e</sub> bar	Type
								Thermostats with cylindrical remote sensor	
								-60 → -25	RT 10
								-45 → -15	RT 9
								-30 → 0	RT 13
								-25 → 15	RT 3,2,7
								-20 → 12	RT 8
								-5 → 10	RT 12
								-5 → 30	RT 14
								-5 → 50	RT 26
								5 → 22	RT 23
								8 → 32	RT 15
								25 → 90	RT 101
								20 → 90	RT 106
								30 → 140	RT 108
								Thermostats with room sensors, duct sensor and capillary tube sensor	
								-50 → -15	RT 17
								-30 → 0	RT 11
								-25 → 15	RT 34
								-5 → 30	RT 4
								10 → 35	RT 115
								10 → 45	RT 103
								15 → 45	RT 140
								40 → 80	RT 141
								25 → 90	RT 102
								Thermostats with adjustable neutral zone	
								-20 → 12	RT 8L
								-5 → 30	RT 14L
								0 → 38	RT 16L
								15 → 45	RT 140 L
								Differential thermostats	
								0 → 15	RT 270
								0 → 20	RT 271

**Technical data and code nos.** When ordering, please state type and code number.

Types of charge  
A: Vapour charge - sensor must not be the warmest part.  
B: Adsorption charge  
C: Partial charge - the sensor must not be the coldest part

Thermostats with cylindrical remote sensor

Preferred charge



RT 107  
with cylindrical remote sensor,  
cover with windows and hand  
setting knob

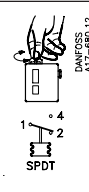
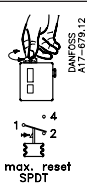
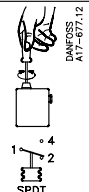

RT 106  
with cylindrical remote sensor,  
cover with windows and hand  
setting knob

Setting range °C	Adjustable differential range*)		Max. sensor temperature °C	Type of charge	Capillary tube length m	Code no.			Type
	At lowest range setting °C	At highest range setting °C							
-60 → -25	1.7 → 7	1 → 3	150	A	2	017-507766			RT 10
-45 → -15	2.2 → 10	1 → 4.5	150	A	2	017-506666			RT 9
-30 → 0	1.5 → 6	1 → 3	150	A	2	017-509766			RT 13
-25 → 15	2.8 → 10	1 → 4	150	A	2	017-501466			RT 3
-25 → 15	2.8 → 10	1 → 4	150	A	5	017-501666			RT 3
-25 → 15	2.8 → 10	1 → 4	150	A	8	017-501766			RT 3
-25 → 15	5 → 18	6 → 20	150	B	2	017-500866			RT 2
-25 → 15	2 → 10	2.5 → 14	150	B	2	017-505366			RT 7
-25 → 15	2 → 10	2.5 → 14	150	B	5	017-505566			RT 7
-25 → 15	2 → 10	2.5 → 14	150	B	8	017-505666			RT 7
-20 → 12	1.5 → 7	1.5 → 7	145	B	2	017-506366			RT 8
-5 → 10	1 → 3.5	1 → 3	65	B	2	017-508966			RT 12
-5 → 30	2 → 8	2 → 10	150	B	2	017-509966			RT 14
-5 → 30	2 → 8	2 → 10	150	B	3	017-510066			RT 14
-5 → 30	2 → 8	2 → 10	150	B	5	017-510166			RT 14
-5 → 30	2 → 8	2 → 10	150	B	8	017-510266			RT 14
-5 → 30	2 → 8	2 → 10	150	B	10	017-510366			RT 14
-5 → 50	2 → 9	3 → 19	150	B	2	017-518066			RT 26
5 → 22	1.1 → 3	1 → 3	85	B	2	017-527866			RT 23
8 → 32	1.6 → 8	1.6 → 8	150	B	2	017-511566			RT 15
25 → 90	2.4 → 10	3.5 → 20	300	B	2	017-500366	017-500466	017-500566	RT 101
25 → 90	2.4 → 10	3.5 → 20	300	B	3	017-500666			RT 101
25 → 90	2.4 → 10	3.5 → 20	300	B	5	017-502266	017-502366		RT 101
25 → 90	2.4 → 10	3.5 → 20	300	B	8	017-502466			RT 101
25 → 90	2.4 → 10	3.5 → 20	300	B	10	017-502566			RT 101
20 → 90	4 → 20	2 → 7	120	C	2	017-504866		017-504966	RT 106
20 → 90	4 → 20	2 → 7	120	C	3			017-505166	RT 106
20 → 90	4 → 20	2 → 7	120	C	5	017-505066			RT 106
30 → 140	5 → 20	4 → 14	220	B	2	017-506066			RT 108
70 → 150	6 → 25	1.8 → 8	215	C	2	017-513566	017-513666	017-513766	RT 107
70 → 150	6 → 25	1.8 → 8	215	C	3	017-513966			RT 107
70 → 150	6 → 25	1.8 → 8	215	C	5	017-514066	017-514166	017-514366	RT 107
70 → 150	6 → 25	1.8 → 8	215	C	8	017-514466			RT 107
70 → 150	6 → 25	1.8 → 8	215	C	10	017-514566			RT 107
120 → 215	7 → 30	1.8 → 9	260	C	2	017-520566 <sup>1)</sup>	017-521166 <sup>1)</sup>		RT 120
120 → 215	7 → 30	1.8 → 9	260	C	5	017-520666 <sup>1)</sup>			RT 120
120 → 215	7 → 30	1.8 → 9	260	C	8	017-520766 <sup>1)</sup>			RT 120
120 → 215	7 → 30	1.8 → 9	260	C	2	017-520866	017-521466 <sup>2)</sup>		RT 120
120 → 215	7 → 30	1.8 → 9	260	C	5	017-520966			RT 120
150 → 250	6.5 → 30	1.8 → 9	300	C	2	017-522066	017-522466		RT 123
150 → 250	6.5 → 30	1.8 → 9	300	C	5	017-522266			RT 123
200 → 300	5 → 25	2.5 → 10	350	C	2	017-522766	017-523166		RT 124
200 → 300	5 → 25	2.5 → 10	350	C	5	017-522966			RT 124

\*) See also pages 5-6

<sup>1)</sup> Thermostats fitted with neon lamp connected to terminal 4

<sup>2)</sup> Thermostat with tamper-proof seal cap

*Thermostats with room sensor, duct sensor and capillary tube sensor* **Preferred versions**

Setting range °C	Adjustable differential range*)		Max. sensor temperature °C	Type of charge	Capillary tube length m	Sensor type**) Figur	Code no.	Type
	At lowest range setting °C	At highest range setting °C						
-50 → -15	2.2 → 7	1.5 → 5	100	A	-	1	<b>017-511766</b>	RT 17
-30 → 0	1.5 → 6	1 → 3	66	A	-	1	<b>017-508366</b>	RT 11
-25 → 15	2 → 10	2 → 12	100	B	-	1	<b>017-511866</b>	RT 34
-5 → 30	1.5 → 7	1.2 → 4	75	A	-	1	<b>017-503666</b>	RT 4
-5 → 30	1.5 → 7	1.2 → 4	75	A	-	1	<b>017-503766<sup>1)</sup></b>	RT 4
10 → 35	<sup>5)</sup>	<sup>5)</sup>	92	B	-	1	<b>017-519766<sup>2)</sup></b>	RT 115
10 → 35	<sup>5)</sup>	<sup>5)</sup>	92	B	-	1	<b>017-519866<sup>3)</sup></b>	RT 115
10 → 45	1.3 → 7	1 → 5	100	A	-	1	<b>017-515566</b>	RT 103
15 → 45	1.8 → 8	2.5 → 11	240	B	2	2	<b>017-523666</b>	RT 140
40 → 80	1.9 → 9	2.5 → 17	250	B	2	2	<b>017-524166</b>	RT 141
25 → 90	2.4 → 10	3.5 → 20	300	B	2	3	<b>017-514766</b>	RT 102

\*) See also pages 5-6

\*\*) See also fig. 1-5

<sup>1)</sup> Bellows with built-in heating element which reduces the thermal differential (220V)

<sup>2)</sup> Can be connected to 220 V and 380 V

<sup>3)</sup> Can be connected to 220 V

<sup>5)</sup> Special thermostat for ventilation plant



Thermostat type RT 115 with room sensor



Thermostat type RT 140 with duct sensor



Neutral zone thermostat type RT 16L with room sensor



Differential thermostat type RT 270

*Thermostats with adjustable neutral zone*

Setting range °C	Mechanical differential °C	Adjustable differential range*)		Max. sensor temperature °C	Type of charge	Capillary tube length m	Sensor type**) Figur	Code no.	Type
		At lowest range setting °C	At highest range setting °C						
-20 → -12	1.5	1.5 → 4.4	1.5 → 4.9	145	B	2	4	<b>017L003066</b>	RT 8L
-5 → 30	1.5	1.5 → 5	1.5 → 5	150	B	2	4	<b>017L003466</b>	RT 14L
0 → 38	1.5 / 0.7	1.5 → 5	0.7 → 1.9	100	A	-	1	<b>017L002466</b>	RT 16L
15 → 45	1.8 / 2	1.8 → 4.5	2 → 5	240	B	2	2	<b>017L003166</b>	RT 140L
25 → 90	2.5 / 3.5	2.5 → 7	3.5 → 12.5	300	b	2	4	<b>017L006266<sup>1)</sup></b>	RT 101L

\*) See fig. 1-5

*Differential thermostats*

Setting range °C	Mechanical differential °C	Operating range (LT element) °C	Max. sensor temperature °C	Type of charge	Capillary tube length m	Sensor type*) Figur	Code no.	Type
0 → 20	3	20 → 100	200	B	2 × 10	5	<b>017D004466</b>	RT 271
0 → 15	2	-30 → 40	65	B	2 × 5	5	<b>017D003166</b>	RT 270

\*) See fig. 1-5

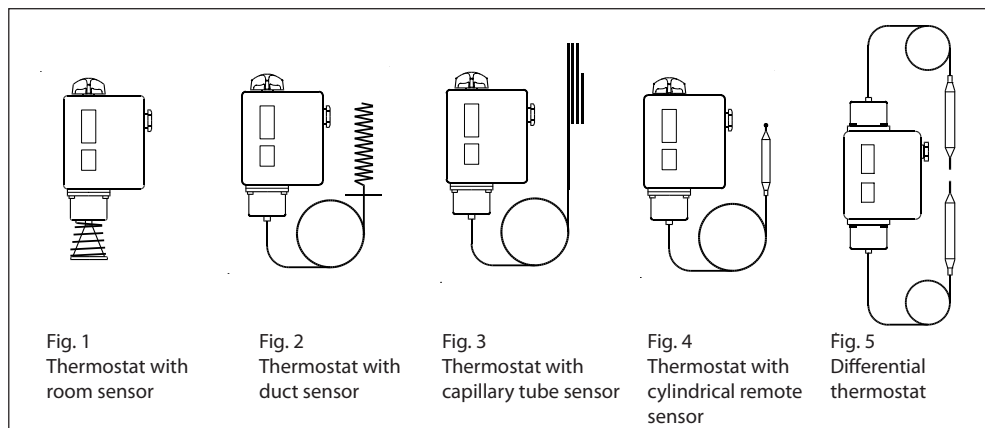



Nomograms for obtained differentials

A = Range setting  
B = Obtained differential  
C = Differential setting

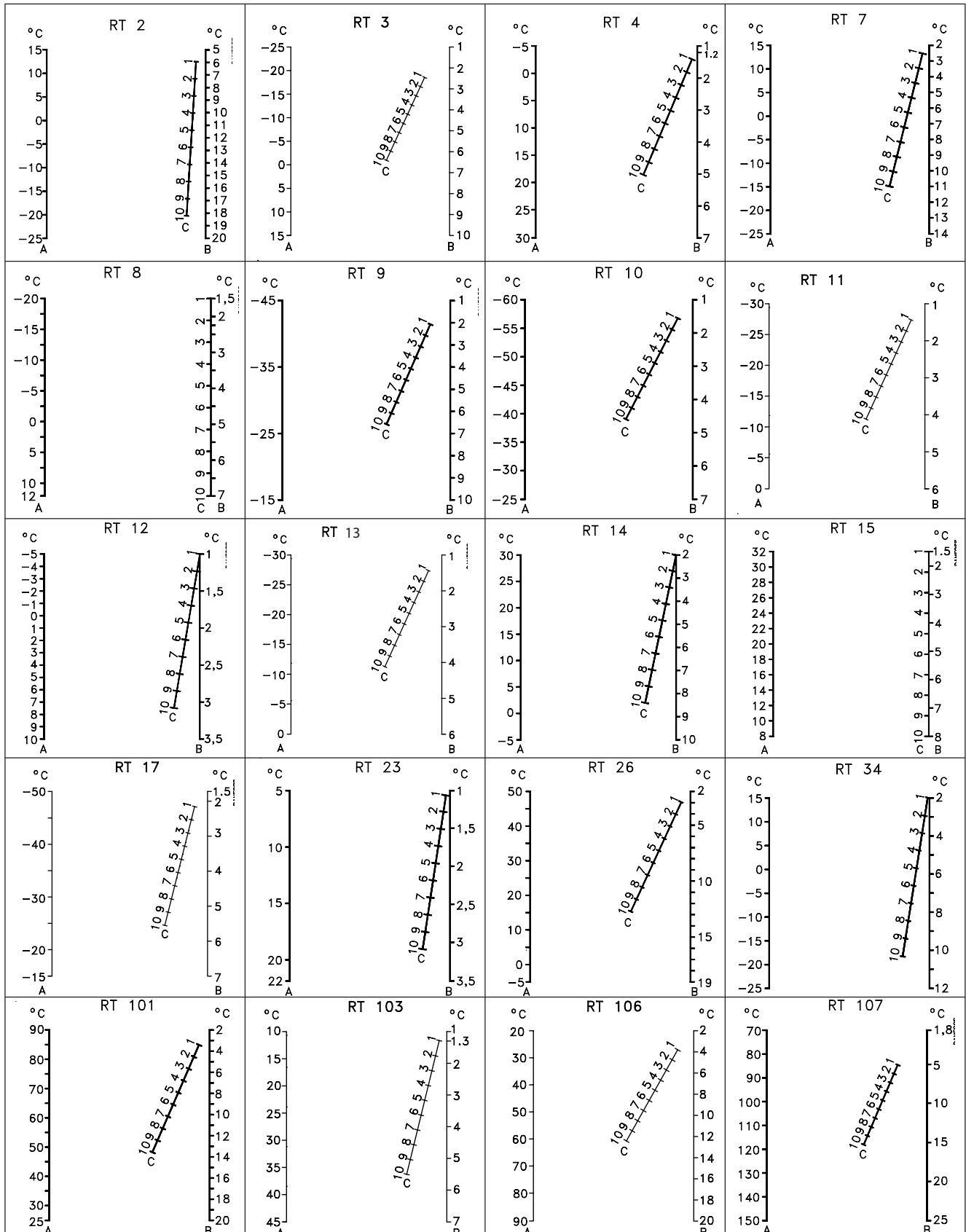

Nomograms for obtained differentials

A = Range setting  
B = Obtained differential  
C = Differential setting

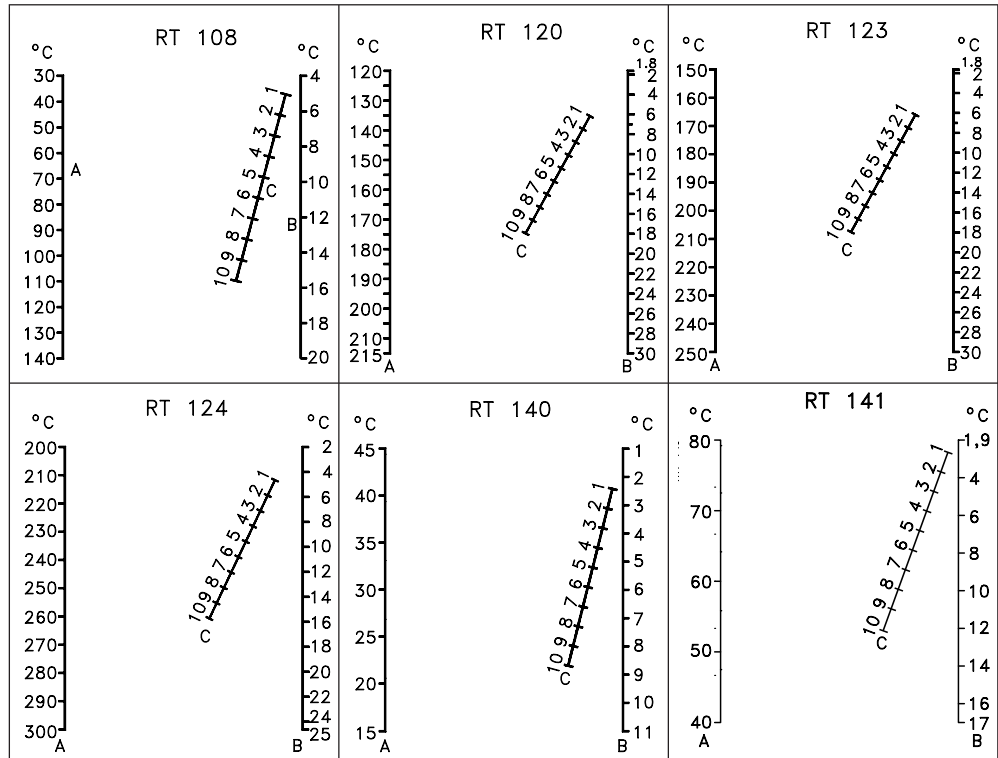

### Technical data

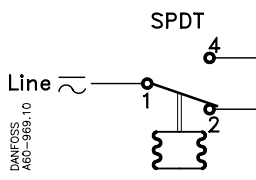
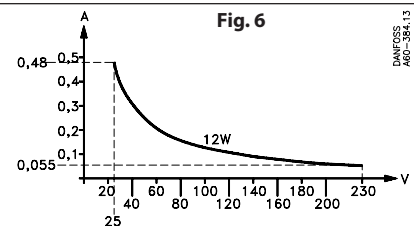
Designation	RT thermostats
Ambient temperature	-50 to 70°C . See remarks on charge types page 11
Contact system	 <p>SPDT</p> <p>Line</p> <p>DANFOSS A60-968.10</p> <p>Single-pole changeover switch (SPDT)</p>
Contact load	<p><b>Alternating current:</b> AC-1: 10A, 400 V AC-3: 4A, 400 V AC-15: 3A, 400 V</p> <p><b>Direct current:</b> DC-13: 12 W, 230 V (see fig. 6)</p>  <p>Fig. 6</p> <p>DANFOSS A60-384.13</p>
Contact material: AgCdO	
Special contact system	See "accessories" pages 15-16
Cable entry	2 PG 13.5 for 6 - 14 mm diameter cables
Enclosure	IP 66 acc. to IEC 529 and EN 60529. Units supplied with external reset. IP 54. The thermostat housing is made of bakelite acc. to DIN 53470 Cover is made of polyamide.

### Approvals

RT 2	RT 4	RT 3	RT 12	RT 16	RT 34	RT 101	RT 106	RT 120	RT 124	Approvals
RT 23	RT 10	RT 7	RT 13	RT 102	RT 103		RT 107			
RT 26	RT 11	RT 8	RT 14	RT 141	RT 115		RT 123			
RT 108	RT 16L	RT 8L	RT 14L	RT 271	RT 140					
	RT 17	RT 9	RT 15	RT 270						
	RT 140L									
x	x	x	x	x	x	x	x	x	x	CE marked acc. to EN 60947-4/-5
						x	x	x	x	Det Norske Veritas, Norway
x	x	x	x	x	x	x	x	x	x	CCC, China Compulsory Certificate
							x			Lloyds Register of Shipping, UK
		x	x			x	x	x		Germanischer Lloyd, Germany
						x				Bureau Veritas, France
x	x	x	x	x	x	x	x	x	x	Registro Italiano Navale, Italy
x	x	x	x	x	x	x	x	x	x	RMRS, Russian Maritime Register of shipping
x		x	x			x	x	x	x	Nippon Kaiji Kyokai, Japan

Note: In addition we refer to the certificates, the copies of which can be ordered from Danfoss.  
GL approval is conditional on the use of a ship's cable entry

### Identification

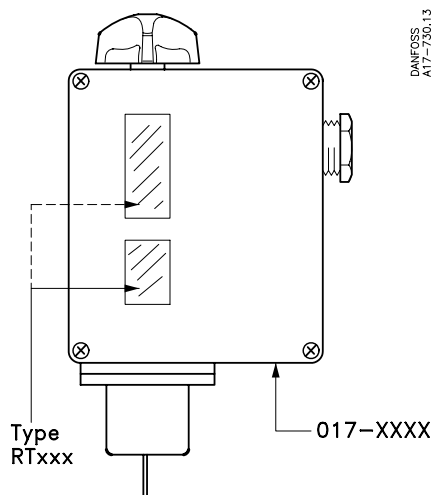

The type designation of the units is given on the setting scale. The code no. is stamped on the bottom of the thermostat housing





## Installation

RT units have two fixing holes which become accessible when the front cover is removed. Units fitted with switch 017-018166\*) must be installed with the setting knob upwards.

The other thermostats in the RT series can be installed in any position, except that on plant subjected to severe vibrations it is advantageous to have the screwed cable entry downwards.

\*) Contact system with non snap-action function. See spare parts and accessories, page 15.

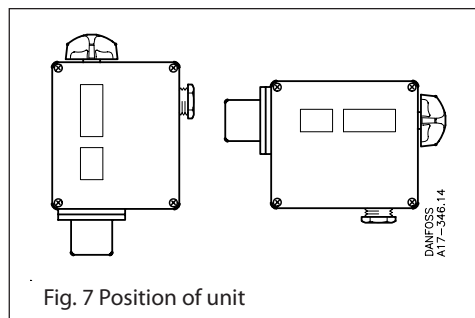
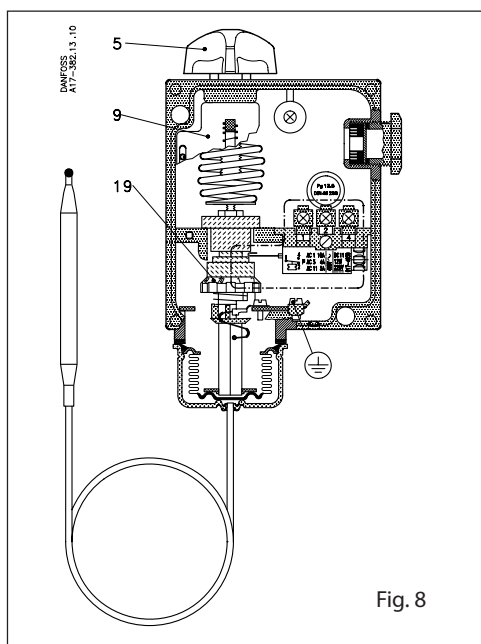

Fig. 7 Position of unit

## Setting



- 5. Setting knob
- 9. Main scale
- 19. Differential setting disc

The range is set by using the setting knob (5) while at the same time reading the main scale (9). Tools must be used to set thermostats fitted with a seal cap. The differential is set by the differential disc (19).

The size of the obtained differential can be established by comparing the set main scale value and the scale value on the differential disc, with the help of the nomogram for the thermostat concerned (see pages 5-6)

### Example

Unit: RT 120  
Range setting: 160°C  
Differential setting: 2

It will be seen on the nomogram on page 6 that by drawing a line from 160°C on scale A, through 2 on scale C, the value for the differential can be read from scale B: 6°C.

### Selection of differential (mechanical differential)

To ensure that the plant functions properly, a suitable differential is necessary. Too small a differential will give rise to short running periods with a risk of hunting. Too high a differential will result in large temperature variations.

### Differentials

The mechanical differential is the differential that is set on the differential disc in the thermostat. The thermal differential (operating differential) is the differential the system operates on. The thermal differential is always greater than the mechanical differential and depends on three factors:

- 1) flow velocity of the medium
- 2) temperature charge rate of the medium and
- 3) heat transmission

### The medium

The fastest reaction is obtained from a medium having high specific heat and high thermal conductivity. It is therefore advantageous to choose a medium that fulfills these conditions (provided there is a choice). The flow velocity of the medium is also of significance. (Optimum flow velocity for liquids is approx. 0.3 m/s).

### Example:

Regulation of a central heating boiler

The temperature in an oil-fired central heating boiler must be regulated by an RT 101. Max. temperature 76°C. Min. temperature 70°C. Differential 76-70 = 6°C.

1. Connect the oil burner via thermostat terminals 1-2.
2. Set the thermostat on 70°C using the hand knob (5), fig. 8.
3. Set the differential disc (19) on 3. This figure is obtained from the RT 101 nomogram, page 5.

When the plant has been operating for some time an assessment can be made of whether the thermal differential is satisfactory. If it is too large, reduce the mechanical differential of the thermostat.

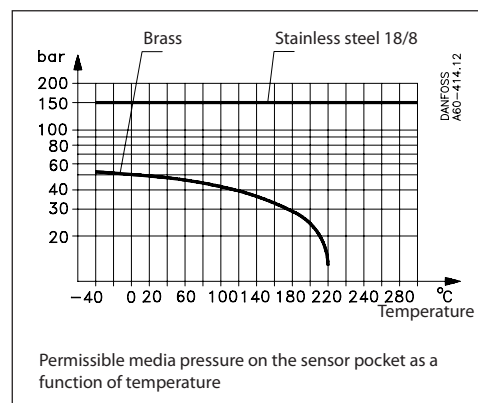

**Function**

a. RT thermostats with automatic reset  
The RT thermostats are set according to the function required on falling temperature. Contacts 1-4 break while contacts 1-2 make when the temperature falls to the scale setting. The contacts changeover to their initial position when the temperature again rises to the scale setting plus the differential (see fig. 9).

**Contact function**

- I. Contact changeover for rising temperature occurs at scale setting plus differential..
- II. Contact changeover for falling temperature occurs at scale setting.

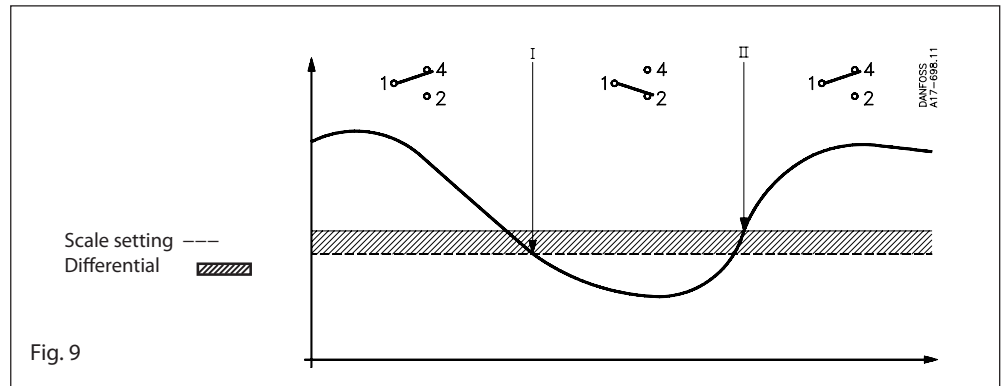

b. RT thermostats with max. reset  
Contacts 1-4 make while contacts 1-2 break when the temperature exceeds the set range value. The contacts changeover to their initial position when the temperature falls to the scale value minus the differential (see fig. 10).

- I. Alarm for rising temperature given at the set value.
  - II. Alarm for falling temperature given at the set value minus the differential.
- Manual reset possible only when the temperature has fallen to the range setting minus differential.

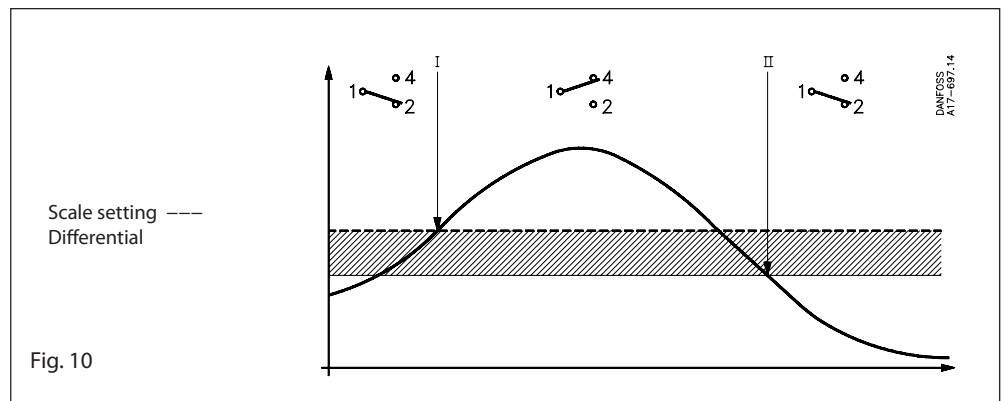

### RT units with vapour charge

The method of operation of these units is based on the connection between the pressure and temperature of saturated vapour. The sensor system contains just a small amount of liquid and this is brought completely to vapour form. If the sensor in this type of unit is located coldest in relation to the capillary tube and bellows housing, the ambient temperature has no influence on regulation accuracy.

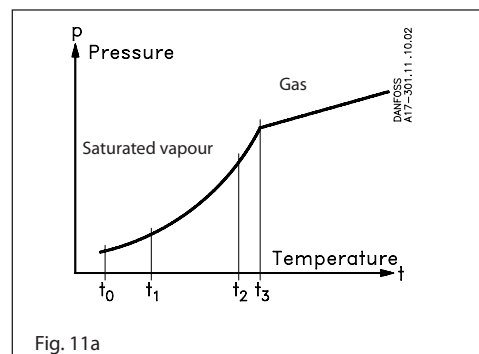

Fig. 11a

### RT units with adsorption charge

The thermostatic element contains a superheated gas together with a solid substance (always in the sensor) having a large adsorption surface. This gives an advantage in that the sensor can be installed either colder or warmer than the remaining part of the thermostatic element. However, the charge is to some extent sensitive to changes in the temperature of the bellows and capillary tube.

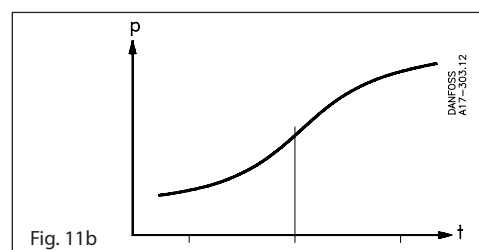

Fig. 11b

#### Scale correction

If the thermostat is to be used in ambient temperatures that differ significantly from the factory setting (20°C), compensation can be made for the scale deviation:  
Scale correction = Z x a  
Z can be found from fig. 11c, while a is the correction factor from the table.

#### Example:

Find the necessary scale correction for a RT 108 with a regulation range +30 to +140°C.  
Setting: 85°C  
Ambient temperature: 50°C  
Correction:

$$\frac{\text{Set value} - \text{min. scale value}}{\text{max. scale value} - \text{min. scale value}} \times 100 = \%$$

$$\frac{85 - 30}{140 - 30} \times 100 = 50\%$$

Correction factor from table 2.0 (a)  
Factor for scale deviation (see fig. 11c): + 1.2 (Z)  
Scale correction: Z x a = 1.2 x 2.0 = 2.4°C  
Corrected setting: 85 + 2.4 = 87.4

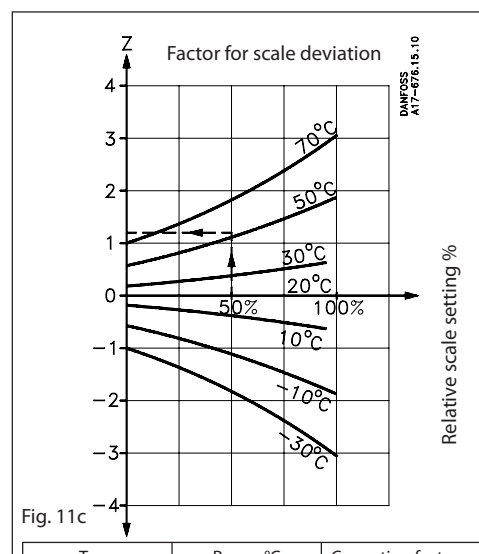

Fig. 11c

Type	Range °C	Correction factor a
RT 2	-25 → 15	2.3
RT 7	-25 → 15	2.9
RT 8/L	-20 → 12	1.7
RT 12	-5 → 10	1.2
RT 14/L	-5 → 20	2.4
RT 15	8 → 32	1.2
RT 23	5 → 22	0.6
RT 101/L	25 → 90	5.0
RT 102	25 → 90	5.0
RT 108	30 → 140	2.0
RT 140/L	15 → 45	3.1

### RT units with solid charge

The method of operation of these units is based on the connection between the pressure and temperature of saturated vapour. The sensor system contains a fairly large amount of liquid, of which only a small part is brought to vapour form. If the sensor in this type of unit is located warmest in relation to the capillary tube and bellows housing, the ambient temperature has no influence on regulation accuracy.

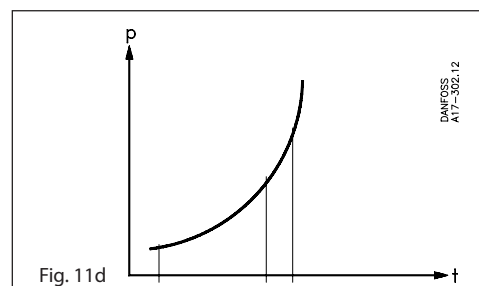
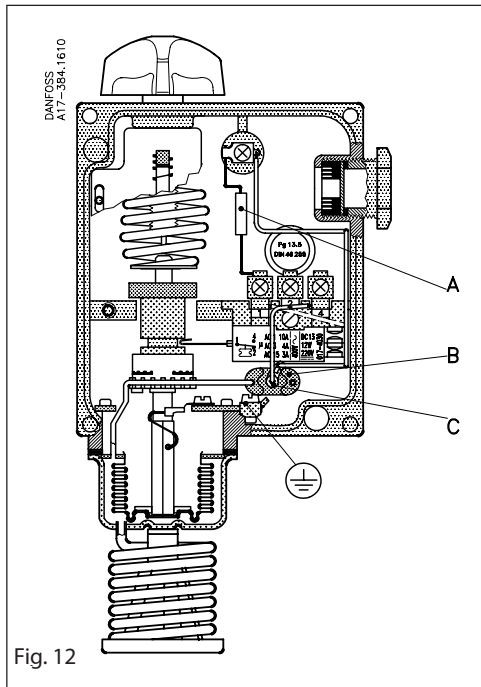

Fig. 11d

**RT 115 for control of ventilation plant in livestock buildings**



- A. Series resistor
- B. Bulb sensor
- C. Heating element

RT 115 has two sensors, each of which is connected to the space between bellows and bellows housing; see fig. 12. One sensor is a normal, external, rigid coiled capillary tube type, the other is a bulb sensor located in the thermostat housing.

The bulb sensor is heated by an element which is cut in when the thermostat stops the fans and is cut out when the thermostat starts the fans.

The for of operation is as follows:

If the room temperature is more than the value set on the thermostat, 20°C for example, the fans run continuously (100% operating time). If the room temperature falls to 20°C, the switch contacts changeover, the fan stops and the bulb sensor heating element cuts in.

When the bulb sensor is heated up, pressure in the sensor system increases and after a certain time the switch changes over again thereby cutting in the fans and cutting out the element. If the room temperature falls more than 2°C under the set temperature - in this example, lower than 18°C - the fans stop completely. The heating element is cut in as usual but can no longer heat the bulb sensor sufficiently to create the required pressure increase in the thermostatic element to cut in the fans again. Thus with a room temperature of less than 18°C the operating time is 0%.

An example is shown in fig. 13. With temperature settings other than the one shown, the inclined line in the diagram is displaced parallel. The line break point on the right of the diagram always corresponds to the set value. It is therefore possible to maintain a stable room temperature and at the same time obtain periodic ventilation where the duration of the ventilation periods depends on the difference between the actual room temperature and the set temperature.

By ensuring that the thermostat is always set at least 2°C over the lowest permissible room temperature, the thermostat will never allow the room temperature to fall below the desired level.

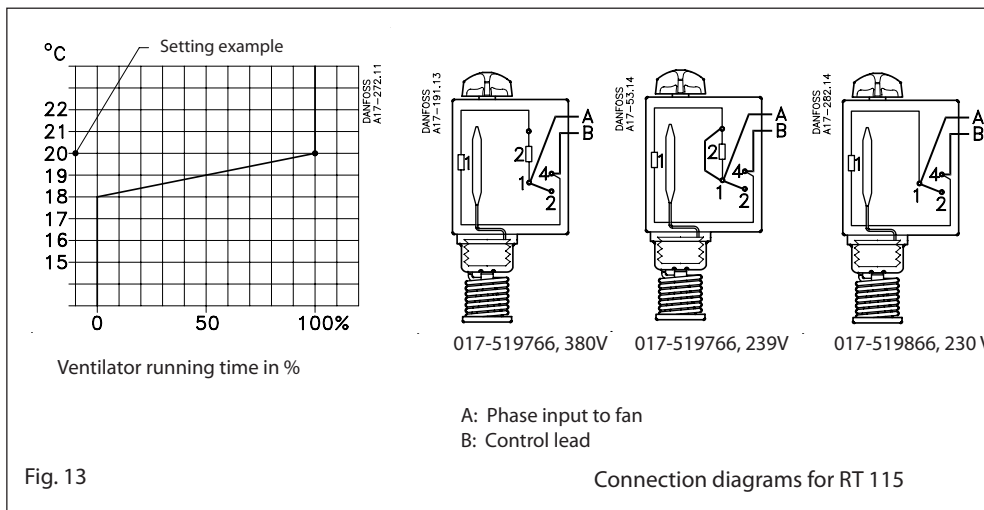

Fig. 13

Connection diagrams for RT 115

**Application**

RT-L thermostats are fitted with an adjustable neutral zone. This enables the units to be used for floating control. The terminology involved is explained below.

*Floating control*

A form of discontinuous control where the correcting element (e.g. valve, damper, or similar) moves towards one extreme position at a rate independent of the magnitude of the error when the error exceeds a definite positive and towards the opposite extreme position when the error exceeds a definite negative value.

*Hunting*

Periodic variations of the controlled variable from the fixed reference.

*Neutral zone*

The interval in the controlled variable in which the correcting element does not respond.

*Mechanical differential*

The interval between the values of the controlled variable in which the correcting element does not respond.

The contact system in neutral zone units cannot be exchanged, as the contact system adjustment is adjusted to the other parts of the unit.

**Neutral zone setting**

- 5. Setting knob
- 9. Main scale
- 40. Neutral zone disc with scale

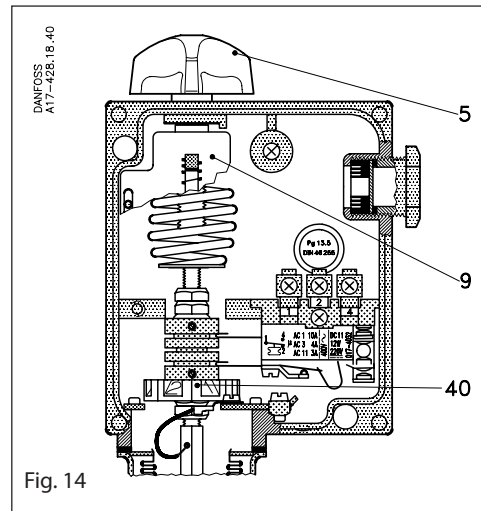

Fig. 14

The range is set using the setting knob (5), fig. 14, while reading the main scale (9). The set value is the break temperature for contacts 1-4, fig. 15. The required neutral zone can be found in the diagram for the unit concerned, fig. 16. The position at which the neutral zone disc (40) must be set can be read from the low scale in the diagram.

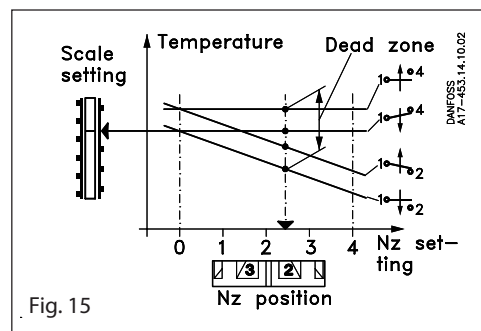

Fig. 15

*Example: RT 16L*

Setting temperature: +24°C  
Required neutral zone: 1.9°C  
Using the setting knob, set the thermostat on 24°C.  
The dotted lines in the diagram for the RT 16L fig. 16 intersect each other on the curve for position 2.8 and the neutral zone setting disc (40) must be set to that position.

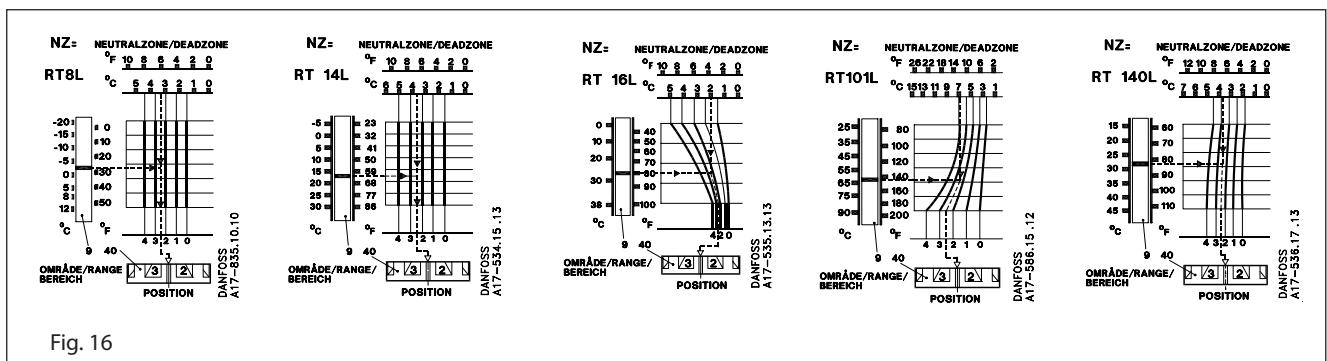

Fig. 16

**Application**

*Control and monitoring of temperature differentials*  
An RT differential thermostat is an electric single-pole changeover switch. The position of the switch contacts is controlled by the difference in temperature between the two sensors of the thermostat. The RT 270 is used in process plant, ventilation

plant and refrigeration and heating plant, where there is a need to maintain a certain temperature difference, from 0 to 20°C, between two media. One of the sensors is used as a reference, the other as an indirect controlled variable. (The direct controlled variable is the temperature differential).

**Setting**

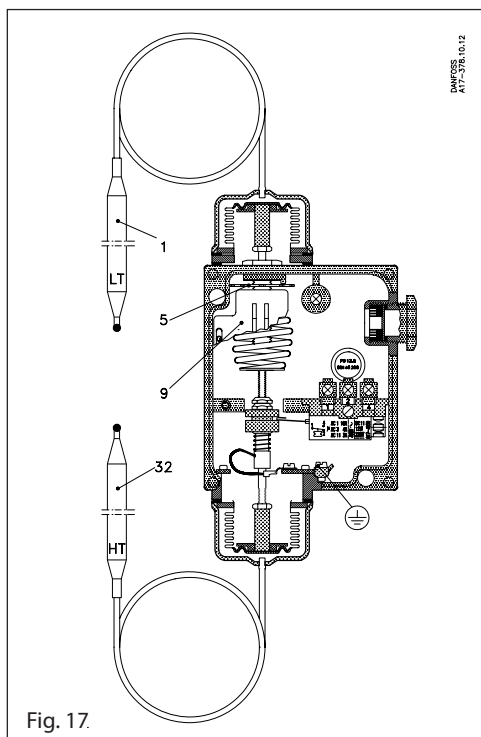

- 1. Sensor for the lowest temperature (LT)
- 5. Setting disc
- 9. Scale
- 32. Sensor for the highest temperature (HT)

The required temperature differential between the LT sensor (1) (lowest temperature) and the HT sensor (32) (highest temperature) is set using the setting disc (5) while reading the scale (9). Fig. 17 is a cross-sectional drawing of the RT 270. The differential thermostat has two bellows elements: an LT element whose sensor must be placed in the medium with the lowest temperature, and an HT element whose sensor must be placed in the medium with the highest temperature. The main spring has a rectilinear characteristic. Within the differential range it can be set for different temperature differentials by means of the setting disc. When the differential between LT and HT sensor temperatures is reduced, the main spindle moves downwards. The contact arm is moved downwards by the guide bush so that contact 1-4 break and contacts 1-2 make when the set temperature differential is reached. The switch contacts change back when the temperature differential has increased to the set value plus the fixed contact differential of approx. 2°C.

**Function**

*Differential thermostats are fitted with a changeover switch (SPDT)*  
When the differential temperature falls below the set value, contacts 1-4 break and contacts 1-2 make. When the differential temperature rises to the set range value plus the fixed contact differential, contacts 1-2 break and contacts 1-4 make.

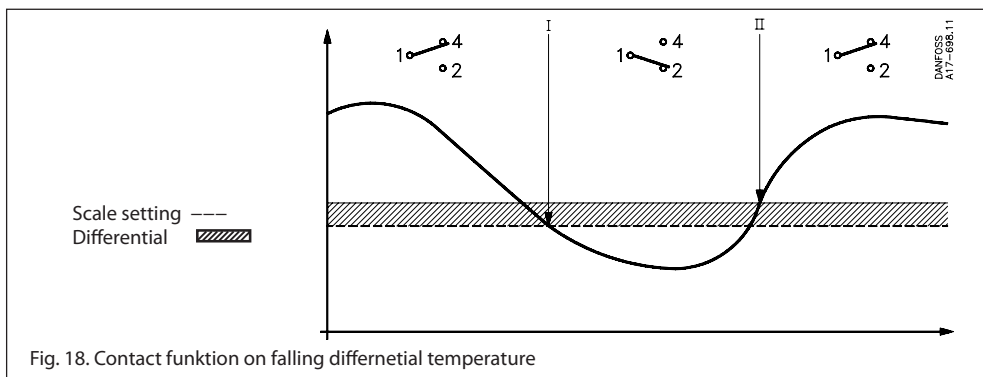

- I. Contacts make when differential temperature falls below the range scale setting.
- II. Contacts make when differential temperature rises above the range scale plus the fixed contact differential.



*Example*  
The temperature rise across an air cooler must be held below 5°C. An alarm must be given when the differential temperature of the cooling water exceeds the 5°C

The choice is an RT 270 with a range of 0-15°C and a fixed contact differential of 2°C.  
Range setting: 5-2°C = 3°C  
When the differential temperature exceeds the range setting plus the fixed contact differential (3+2°C) an alarm will be given.

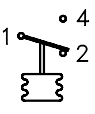
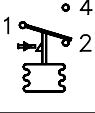

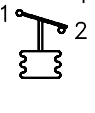
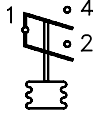
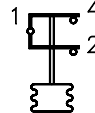
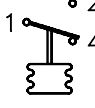
**Spare parts and accessories**





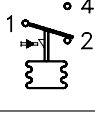

Version	Symbol	Description	Contact rating	Code no.
Standard		Single-pole changeover switch (SPDT) with terminal board proof against leakage current <b>Fitted in all standard versions of type RT<sup>1)</sup>.</b> Snap action changeover contacts.	<i>Alternating current:</i> AC-1 (ohmic): 10 A, 400 V AC-3 (inductive): 4 A, 400 V AC-14/15 (coil/transformer): 3 A, 400 V Blocked rotor: 28 A, 400 V <i>Direct current:</i> DC 13/14: 12 W, 230 V	<b>017-403066</b>
With max. reset		For manual reset of unit after contact changeover on rising pressure <b>For units with max. reset.</b>		<b>017-404266</b>
With min. reset		For manual reset of units after contact changeover on falling pressure. <b>For units with min. reset.</b>		<b>017-404166</b>
Standard		Single-pole changeover switch (SPDT) with gold plated (oxide-free) contact surfaces. Increases cut-in reliability on alarm and monitoring systems, etc. Snap action changeover contacts. Terminal board proof against leakage current.	<i>Alternating current:</i> AC-1 (ohmic): 10 A, 400 V AC-3 (inductive): 2 A, 400 V AC-14/15: 1 A, 400 V Blocked rotor: 14 A, 400 V <i>Direct current:</i> DC-13/14: 12 W, 230 V	<b>017-424066</b>
Cuts in two circuits simultaneously		Single-pole changeover switch that cuts in two circuits simultaneously on rising pressure. Snap action changeover contacts. Terminal board proof against leakage current.	<i>Alternating current:</i> AC-1 (ohmic): 10 A, 400 V AC-3 (inductive): 3 A, 400 V AC-14/15: 2 A, 400 V Blocked rotor: 20 A, 400 V <i>Direct current:</i> DC-13/14: 12 W, 230 V	<b>017-403466</b>
Cuts out two circuits simultaneously		Single-pole changeover switch that cuts out two circuits simultaneously on rising pressure. Snap action changeover contacts. Terminal board proof against leakage current.	* If current is led through contacts 2 and 4, i.e. terminals 2 and 4 connected but not 1, max. permissible load is increased to 90 W, 220 V - - -.	<b>017-403666</b>
With non-snap action changeover contacts		Single-pole changeover with non-snap action changeover gold plated (oxide-free) contacts.	<i>Alternating or direct current:</i> 25 VA, 24 V	<b>017-018166</b>

<sup>1)</sup> At load types with low currents/voltages contact failure may occur on the silver contacts because of oxidation. In systems where such a contact failure is of great importance (alarm etc.), gold plated contacts are recommended.  
**Contact systems for neutral zone units are not available as spare parts. Exchange not possible, as the contact system adjustment is adjusted to the other parts of the unit.**

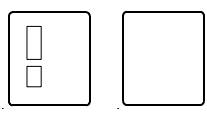
The switch contacts are shown in the position they assume on falling temperature, i.e. after downward movement of the RT main spindle.  
 The setting pointer of the control shows the scale value at which contact changeover occurs on falling temperature. An exception is switch no. **017-403066** with max. reset where the setting pointer shows the scale value at which contact changeover occurs on rising pressure.

**Switches**

Version	Symbol	Description	Contact rating	Code no.
With min. reset		For manual reset of unit after contact changeover on falling pressure. Gold plated (oxide-free) contact surfaces	<i>For Alarm application</i> <i>Alternating current:</i> AC-1 (ohmic): 10 A, 400 V AC-3 (inductive): 2 A, 400 V Full load current: 2 A, 400 V AC-14/15: 1 A, 400 V Blocked rotor: 14A, 400 V	<b>017-404766</b>
With max. reset		For manual reset of unit after contact changeover on rising pressure. Gold plated (oxide-free) contact surfaces	<i>Direct current</i> DC-13/14: 12W, 230 V  <i>For control application</i> max. 100 mA / 30 V a.c. / d.c. min. 1 mA / 5 V a.c. / d.c.	<b>017-404866</b>

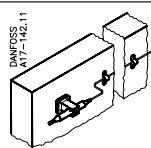
Part		Description	Qty.	Code no.
Cover		Covers: Polyamide	5	<b>017-436166</b>
		Colour: Pale grey RAL 7035	5	<b>017-436266</b>
Setting knob		Replacement Pale grey Ral 7035	30	<b>017-436366</b>
Seal cap		Seal cap to replace setting knob so that Setting can only be altered with tools	20	<b>017-436066</b>
Seal screws for cover and seal cap			1 + 1	<b>017-425166</b>
Capillary tube gland		For all RT thermostats with remote sensor. G $\frac{1}{2}$ A (pipe thread ISO 228/1), oil resistant rubber washer for max. 110°C/90 bar	5	<b>017-422066</b>
Capillary tube gland		For RT 106 thermostats with remote sensor. G $\frac{3}{4}$ A (pipe thread ISO 228/1), oil resistant rubber washer for max. 110°C/90 bar	1	<b>003N0155</b>
Sensor clip		For all RT units with remote sensor L = 76 mm	10	<b>017-420366</b>
Heat conductive compound		For RT thermostats with the sensor insert in a pocket. Tube with 3.5cm <sup>3</sup> compound to be filled in the sensor pocket to improve heat transfer between pocket and sensor. Application range for compound: -20 to +150°C, momentarily up to 220°C	10	<b>041E0114</b>
Sensor holder		For RT 14, 101 and 270 Sensor holder for wall mounting incl. four capillary tube clips	20 set	<b>017-420166</b>

#### Sensor pocket for RT thermostats with cylindrical remote sensor

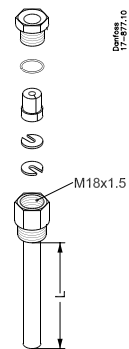
Used for the following types		Insertion length L mm	d mm	Material	Connection pipe thread ISO 228/1	Code no.
All except RT 12, 23, 106, 108, 124, 270		112	11	Brass	G $\frac{1}{2}$ A	<b>017-437066</b>
All except RT 12, 23, 106, 108, 124, 271		112	11	Stainless steel 18/8		<b>017-436966</b>
RT 106, RT 124 <sup>2)</sup>		110	15	Brass		<b>060L327166<sup>1)</sup></b>
RT 106, RT 124 <sup>2)</sup>		110	15	Stainless steel 18/8		<b>060L326866<sup>1)</sup></b>
RT 106, RT 124 <sup>2)</sup>		160	15	Brass		<b>060L326366<sup>1)</sup></b>
RT 106, RT 124 <sup>2)</sup>		160	15	Stainless steel 18(8)		<b>060L326966<sup>1)</sup></b>
RT 271		182	11	Brass		<b>017-436766</b>
RT 108		465	11	Brass		<b>017-421666</b>

<sup>1)</sup> Supplied without washer set  
<sup>2)</sup> Unit supplied with washer set